

Accessori

「terre







450

*Accessories*

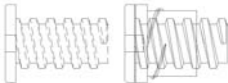









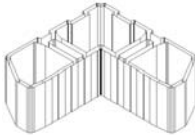



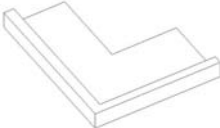

450





terre



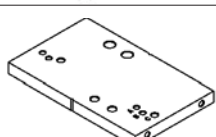
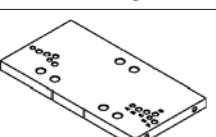

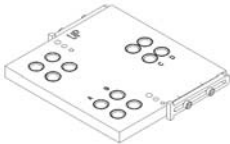
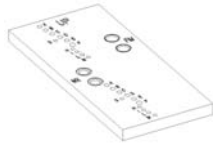
ACCESSORI TIERRE 450 "VARI"		
sigla	profilo	descrizione
Ra 1033		CAPPETTA DI DRENAGGIO
Ra 1404		REGOLATORE A MURO
Ra 1420		CAVALLOTTO PER TR4710
Ra 1421		CAVALLOTTO PER TR4711
Ra 1422		ANGOLI PER FERMAVETRI ARROTONDATI
Ra 1477		FERMA PERSIANA UNICA
Ra 1478		TAPPO DX E SX PER LAMELLE FISSE A 30°
Ra 2601		BOCCOLA SCARICO ACQUA



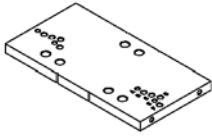



ACCESSORI TIERRE 450 "SQUADRETTE"

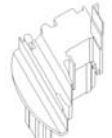
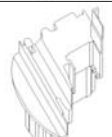

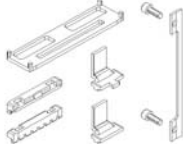
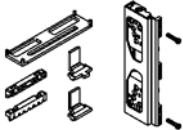



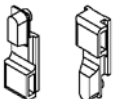

sigla	profilo	descrizione
Ra 1048		SQUADRETTA PRESSOFUSA A TIRAGGIO ESTERNO
Ra 1405		SQUADRETTA A SPINARE PICCOLA
Ra 1406		SQUADRETTA PRESSOFUSA A TIRAGGIO ESTERNO PICCOLA
Ra 1407		SQUADRETTA A SPINARE MAGGIORATA
Ra 1408		SQUADRETTA PRESSOFUSA A TIRAGGIO ESTERNO MAGGIORATA
Ra 1423		SPINA DA 13,5 mm
Ra 1704		SQUADRETTA DI ALLINEAMENTO

ACCESSORI TIERRE 450 "CERNIERE"		
sigla	profilo	descrizione
Ra 1427		CERNIERA FLASH BASE
Ra 1428		CERNIERA FLASH BASE PER SOLUZIONE COMPLANARE O 3° ANTA
Ra 1430		CERNIERA PER PORTE FLASH XL
Ra 1431		CERNIERE PER PORTE FLASH XL SOL. COMPLANARE O 3° ANTA
Ra 1440		CERNIERA PER VASISTAS
Ra 1424		CERNIERA DOMINA 2 ALI int. 61 mm
Ra 1425		CERNIERA DOMINA 3 ALI int. 61 mm
Ra 1426		CERNIERA DOMINA 2 ALI int. 55,5 mm
Ra 1432		CERNIERA DOMINA 2 ALI 3D int. 55,5 mm
Ra 1448		DIMA PER CERNIERA Ra 1426
Ra 1449		DIMA PER CERNIERE Ra 1424 e Ra 1425

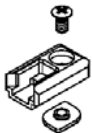
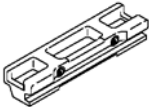
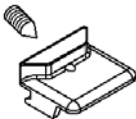
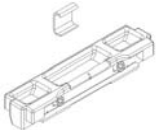







ACCESSORI TIERRE 450 "CERNIERE"		
sigla	profilo	descrizione
Ra 1450		DIMA PER CERNIERE Ra 1463 e Ra 1464
Ra 1451		DIMA PER CERNIERA Ra 1432
Ra 1463		CERNIERA DOMINA HP 2 ALI int. 62,5 mm
Ra 1464		CERNIERA DOMINA HP 3 ALI int. 62,5 mm
Ra 1473		CERNIERA DOMINA 2 ALI int. 68,5 mm.
Ra 1474		CERNIERA DOMINA 3 ALI int. 68,5 mm.
Ra 1475		DIMA PER CERNIERE Ra 1473 e Ra 1474

ACCESSORI TIERRE 450 "TAPPI"		
sigla	profilo	descrizione
Ra 1051		TAPPO ANTINTESTATURA PER AZ 2020 H=18mm
Ra 1052		TAPPO ANTINTESTATURA PER AZ 2020 H=22mm
Ra 1060		SELLA PER PERSIANA FISSA DA 25 mm H=18mm
Ra 1061		SELLA PER PERSIANA FISSA DA 25 mm H=22mm
Ra 3802		TAPPO RISCONTRO CENTRALE GIUNTO APERTO
Ra 3803		TAPPO RISCONTRO CENTRALE DOPPIA BATTUTA

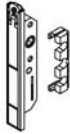
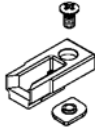
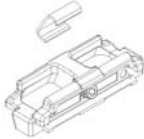
ACCESSORI TIERRE 450 "CREMONESI"		
sigla	profilo	descrizione
Ra 1031		CREMONESE UNICA PER APERTURA INT/EST
Ra 1454		BLOCCHETTI DI COLLEGAMENTO CON VITI DA ABBINARE A Ra 1031 PER APERTURA INTERNA
Ra 1029		KIT DA ABBINARE A Ra 1031 PER APERTURA ESTERNA
Ra 1055		CREMONESE "DOMINGA" PER TR 4730 (apertura interna)
Ra 1056		CREMONESE PRIMA
Ra 1057		CREMONESE PRIMA 900 PER ANTA RIBALTA
Ra 1418		CREMONESE "ELISA" PER TR 4731 (APERTURA INTERNA)
Ra 1465		CREMONESE PER APERTURA ESTERNA (PROFILI MAGGIORATI)
Ra 1429		CRICCHETTO CICO
Ra 1447		BLOCCHETTI DI COLLEGAMENTO PER CREMONESE PRIMA Ra 1056

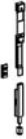
ACCESSORI TIERRE 450 "ACCESSORI DI CHIUSURA"		
sigla	profilo	descrizione
Ra 1002		TERMINALE PER ASTE
Ra 1035		CATENACCIO GIAP IN NYLON
Ra 2905		INCONTRO ASTE E TERZA CHIUSURA IN ZAMA
Ra 2906		INCONTRO SINGOLO-DOPPIO IN NYLON
Ra 2907		INCONTRO PER art. Ra 2918
Ra 2908		INCONTRO DOPPIO IN ZAMA
Ra 2909		ROSTRO DI CHIUSURA REGISTRABILE SU LATO CERNIERA
Ra 2910		BRACCIO LIMITATORE DI APERTURA FRIZ
Ra 2911		BRACCIO LUNGO RALLENTY mm250
Ra 2912		BRACCIO CORTO RALLENTY mm150
Ra 2913		CATENACCIO CON PUNTALE ECCENTRICO REGISTRABILE

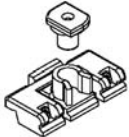





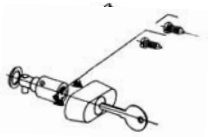

ACCESSORI TIERRE 450 "ACCESSORI DI CHIUSURA"		
sigla	profilo	descrizione
Ra 2914		TAPPO SOSTENIMENTO ANTE
Ra 2915		MARTELLINA MASTERMAR**
Ra 2918		NOTTOLINO DI CHIUSURA SUPPLEMENTARE
Ra 1433		MOVIMENTAZIONE INTERNA BIDIREZIONALE
Ra 1436		INCONTRO DOPPIO E TERZA CHIUSURA IN NYLON
Ra 1437		INCONTRO SINGOLO IN ZAMA
Ra 1441		TERMINALE REGISTRABILE CON PUNTALE ECCENTRICO
Ra 1442		CATENACCIO TOTEM
Ra 1444		CATENACCIO BIDIREZIONALE A LEVA
Ra 1445		FERMA ANTA
Ra 1446		FERMO DI COLLEGAMENTO

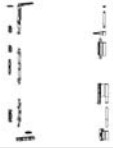



**ACCESSORI TIERRE 450 "ACCESSORI DI CHIUSURA"**

sigla	profilo	descrizione
Ra 1452		ASTINA DI COLLEGAMENTO 15/20 IN POLIAMMIDE (Rotolo da 250m)
Ra 1057		SERRATURA DI BLOCCAGGIO

**ACCESSORI TIERRE 450 "ANTA RIBALTA BASE"**

sigla	profilo	descrizione
Ra 1458		MECC. BASE AR FUTURA
Ra 1459		BRACCIO TIPO 1 AR FUTURA
Ra 1460		BRACCIO TIPO 2 AR FUTURA
Ra 1461		CHIUSURA SUPPLEMENTARE FUTURA
Ra 2921		CATENACCIO REGISTRABILE ANTA ABBINATA
Ra 2922		CATENACCIO GIAP ANTA ABB. AD A/R IN NYLON
Ra 2923		BRACCIO SUPPLEMENTARE PER A/R

**ACCESSORI TIERRE 450 "ANTA RIBALTA BASE"**

sigla	profilo	descrizione
Ra 1456		CATENACCIO ANTA ABBINATA AD A/R
Ra 1443		CATENACCIO BID. A LEVA PER A/R
Ra 1435		MOVIMENTAZIONE INTERNA MONODIREZIONALE PER A/R
Ra 1462		CERNIERA ANTA ABBINATA A Ra 1458

**ACCESSORI TIERRE 450 "ANTA RIBALTA PER SOLUZIONE COMPLANARE"**

sigla	profilo	descrizione
Ra 1455		MECCANISMO ANTA RIBALTA PER SOLUZIONE COMPLANARE
Ra 1025		CATENACCI ANTA ABBINATA APPLICABILE A RA 1455
Ra 1044		BRACCIO TIPO 1 A.R APPLICABILE A RA 1455
Ra 1045		BRACCIO TIPO 2 A.R APPLICABILE A RA 1455
Ra 2919		CHIUSURE SUPPL. VERTICALI APPLICABILE A RA 1455

**ACCESSORI TIERRE 450 "ANTA RIBALTA PER SOLUZIONE COMPLANARE"**

sigla	profilo	descrizione
Ra 2920		CHIUSURE SUPPL. ORIZZONTALI APPLICABILE A RA 1455







**ACCESSORI TIERRE 450 "MONOBLOCCO"**



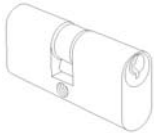

sigla	profilo	descrizione
Ra 1036		PASSACINTINO
Ra 1058		TAPPO RACCOGLI CONDENSA
Ra 1073		TAPPI CASSONETTO MONOBLOCCO
Ra 1419		COPPIA INVITI PER GUIDA TAPPARELLA
Ra 1476		KIT MOVIMENTAZIONE MONOBLOCCO

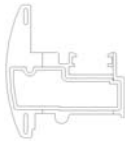
**ACCESSORI TIERRE 450 "GRUPPI FRESE E PUNZONATRICI"**

sigla	profilo	descrizione
Ra 3800		PUNZONATRICE TIERRE
Ra 3801		GRUPPO FRESE

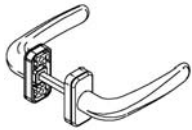
**ACCESSORI TIERRE 450 "SERRATURE"**

sigla	profilo	descrizione
Ra 1008		SERRATURA PER FASCIA AZ 2020 E AZ2021 - ENTRATA - 80 MM
Ra 1009		SERRATURA PER FASCIA AZ 4514 - ENTRATA - 80 MM
Ra 1013		SERRATURA PER MONTANTE - ENTRATA 30 MM
Ra 1072		CILINDRO OVALE
Ra 1414		CONTROPIASTRA PER SERRATURA A FASCIA Ra 1008 e Ra 1009
Ra 1415		CONTROPIASTRA PER SERRATURA A MONTANTE Ra 1013
Ra 1466		DOPPIA MANIGLIA PER MONTANTE

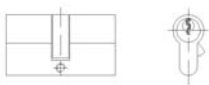
ACCESSORI TIERRE 450 "SERRATURE"		
sigla	profilo	descrizione
Ra 1467		DOPPIA MANIGLIA PER FASCIA
Ra 1468		SERRATURA MULTIPUNTO MULTITOP ENTRATA 30 mm
Ra 1469		CONTROPIASTRA PER SERRATURA MULTIPUNTO Ra 1468
Ra 1470		DEVIATORI PER SERRATURA MULTIPUNTO Ra 1468
Ra 1471		SERRATURA MULTIPUNTO MULTITIPO ELETTRICA ENTRATA 30 mm
Ra 1472		CILINDRO SAGOMATO

Guarnizioni

「*terre*」

450

*Weatherstrips*









*terre* 450

Rg 402		Guarnizione di battuta interna Materiale EPDM	3 Rotoli da 300 m
Rg 362		Guarnizione centrale di tenuta Materiale EPDM	4 Rotoli da 50 m
Rg 363		Angolo Vulcanizzato per Rg 403 Materiale EPDM	50 pezzi
Rg 361		Guarnizione di battuta - soluzione a doppia battuta - Materiale EPDM	2 Rotoli da 300 m
Rg 331		Guarnizione per riscontro centrale Materiale EPDM	3 Rotoli da 300 m
Rg 329		Guarnizione copricava Materiale EPDM	2 Rotoli da 150 m
Rg 358		Spugna per Monoblocco	
Rg 303		Guarnizione per riscontro centrale - soluzione a doppia battuta - Materiale EPDM	2 Rotoli da 300 m
Rg 350		Guarnizione esterna vetro per vano da mm 2,5 Materiale EPDM	Rotolo da 200 m
Rg 351		Guarnizione esterna vetro per vano da mm 3,5 Materiale EPDM	Rotolo da 150 m
Rg 360		Guarnizione esterna vetro per vano da mm. 5 Materiale EPDM	2 Rotoli da 150 m
Rg 307		Guarnizione interna vetro per vano da mm. 2 Materiale EPDM	2 Rotoli da 300 m

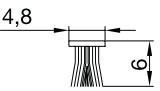
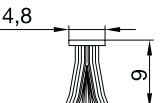
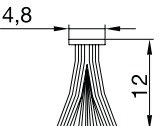

Guarnizioni Weatherstrips

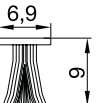
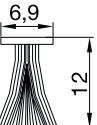
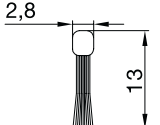
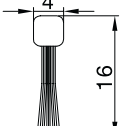
Rg 320		Guarnizione interna vetro per vano da mm. 3 Materiale EPDM	2 Rotoli da 200 m
Rg 308		Guarnizione interna vetro per vano da mm. 4 Materiale EPDM	2 Rotoli da 150 m
Rg 321		Guarnizione interna vetro per vano da mm. 5 Materiale EPDM	2 Rotoli da 150 m
Rg 309		Guarnizione interna vetro per vano da mm. 6 Materiale EPDM	2 Rotoli da 100 m
48 x 600		Guarnizione a spazzola mm 4,8 x 6 Materiale polipropilene	4 Rotoli da 400 m
48 x 900		Guarnizione a spazzola mm 4,8 x 9 Materiale polipropilene	4 Rotoli da 200 m
48 x 1200		Guarnizione a spazzola mm 4,8 x 9 Materiale polipropilene	2 Rotoli da 200 m
69 x 600		Guarnizione a spazzola mm 6,9 x 6 Materiale polipropilene	5 Rotoli da 100 m
69 x 900		Guarnizione a spazzola mm 6,9 x 9 Materiale polipropilene	4 Rotoli da 200 m
69 x 1200		Guarnizione a spazzola mm 6,9 x 12 Materiale polipropilene	2 Rotoli da 200 m
28 x 1300		Guarnizione a spazzola mm 13 Materiale polipropilene	barre da 2 m
40 x 1600		Guarnizione sottozoccolo a spazzola mm 13 Materiale polipropilene	barre da 2 m

Scala 1:1

Squadrette

┌ tierre 450 ┐

*Joint corner*



tierre 450

Squadrette joint corner

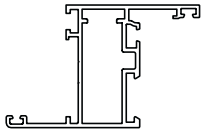
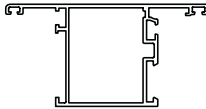
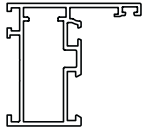
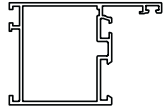
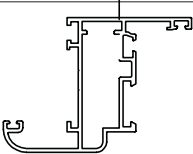
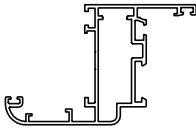
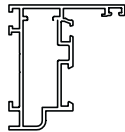
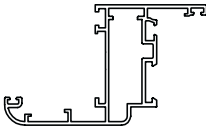
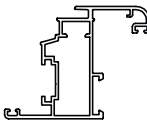
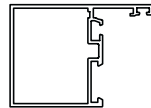
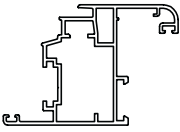
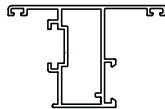
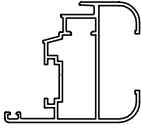
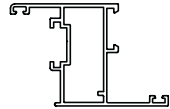
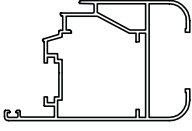
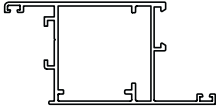
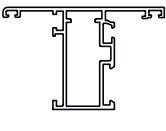
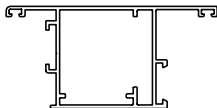
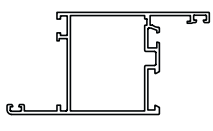
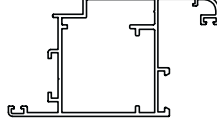
profilo	sigla	squadretta	profilo	sigla	squadretta
	TR 4701	Ra 1048		TR 4719	Ra 1407 Ra 1408
	TR 4702	Ra 1048		TR 4720	Ra 1407 Ra 1408
	TR 4703	Ra 1048		TR 4721	Ra 1048
	TR 4704	Ra 1048		TR 4722	Ra 1048
	TR 4705	Ra 1048		TR 4723	Ra 1407 Ra 1408
	TR 4706	Ra 1048		TR 4724	Ra 1048
	TR 4707	Ra 1048		TR 4725	Ra 1048
	TR 4708	Ra 1405 Ra 1406		TR 4726	Ra 1405 Ra 1406
	TR 4717	Ra 1048		TR 4727	Ra 1405 Ra 1406
	TR 4718	Ra 1407 Ra 1408		TR 4728	Ra 1405 Ra 1406

Squadrette joint corner

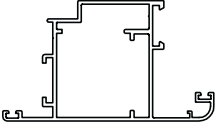
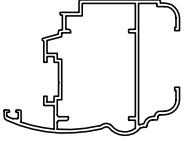
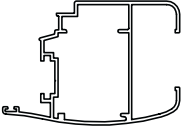
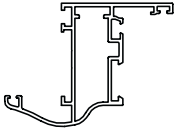
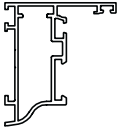
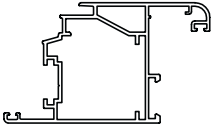
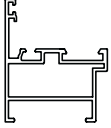
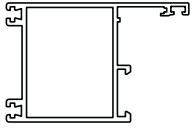
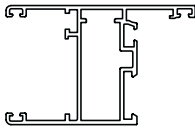
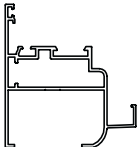
			profilo	sigla	squadretta
	TR 4729	Ra 1405 Ra 1406			
	TR 4730	Ra 1405 Ra 1406			
	TR 4731	Ra 1405 Ra 1406			
	TR 4732	Ra 1048			
	TR 4733	Ra 1048			
	TR 4764	Ra 1405 Ra 1406			
	TR 4765	Ra 1048			
	TR 4768	Ra 1407 Ra 1408			
	TR 4771	Ra 1048			
	TR 4772	Ra 1048			